



SAFETY & CONVENIENCE

Inspiration for your Safety



ENDURING *style*

GLASS CLAMPS, SHELF SUPPORT HARDWARE & ACCESSORIES

Looking for a long term design solution for your sneeze guards that provides a beautiful aesthetic?

For glass or acrylic, our wide range of glass clamps and shelf support hardware are made with high-grade materials for durability and designed to provide a beautiful finish. Install some of our easy to clean stainless steel knobs for enhanced functionality on openings.

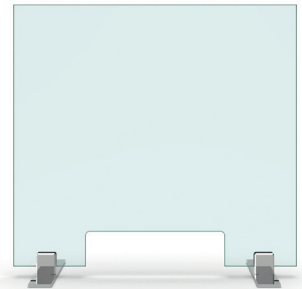
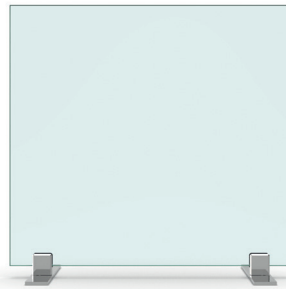

Glass Standoff - 9342/9001 Series

Glass Thickness: 1/4"~1/2" (6~12 mm)

Material: Zinc Alloy

Finish: Stainless Steel, Aluminum



Glass Standoff - 31322

Glass Thickness: 5/16"~1/2" (8~12 mm)

Material: Zinc Alloy

Finish: Stainless Steel, Aluminum

Glass Standoff - 3001 Series

Glass Thickness: 1/4" (6 mm)

Material: Zinc Alloy

Finish: Stainless Steel, Aluminum

Glass Standoff - 7140E1EV1

Glass Thickness: 1/8"~1/4" (3~6 mm)

Material: Aluminum/Brass

Finish: Anodized/Nickel Plated

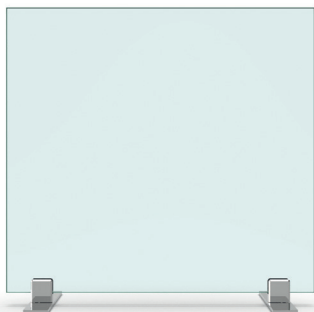

Showing the 9342/9001 Series

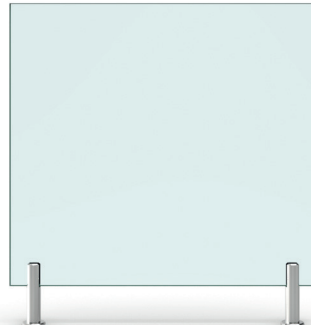

Showing the 31322 Series

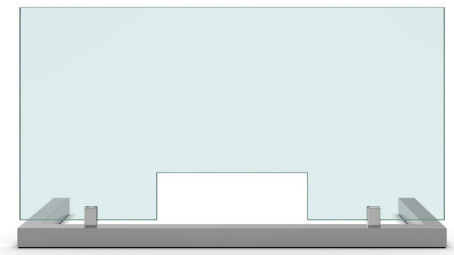

Showing the 3001 Series

Please note: These are examples of applications, Sugatsune does not sell the glass or acrylic with the hardware itself.



(Shown Above)

Glass Standoff - 3021 Series

Glass Thickness: 1/4" (6 mm)
 Material: Zinc Alloy
 Finish: Stainless Steel, Matte Brush

Glass Standoff - 8195 Series

Glass Thickness: 1/4"~ 3/8" (6~10 mm)
 Material: Zinc Alloy
 Finish: Stainless Steel, Glass Chrome

Glass Standoff -2879/2877 Series

Glass Thickness: 1/4"~ 3/8" (6~10 mm)
 Material: Zinc Alloy
 Finish: Stainless Steel, Glass Chrome

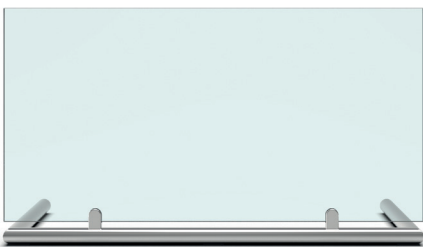

Showing the 3021 Series

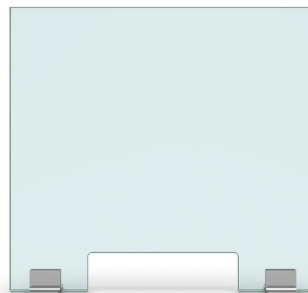

Showing the 8195 Series

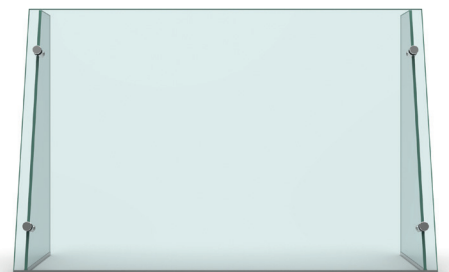

Showing the 2879/2877 Series

Please note: These are examples of applications, Sugatsune does not sell the glass or acrylic with the hardware itself.



• BANKS & HOTELS

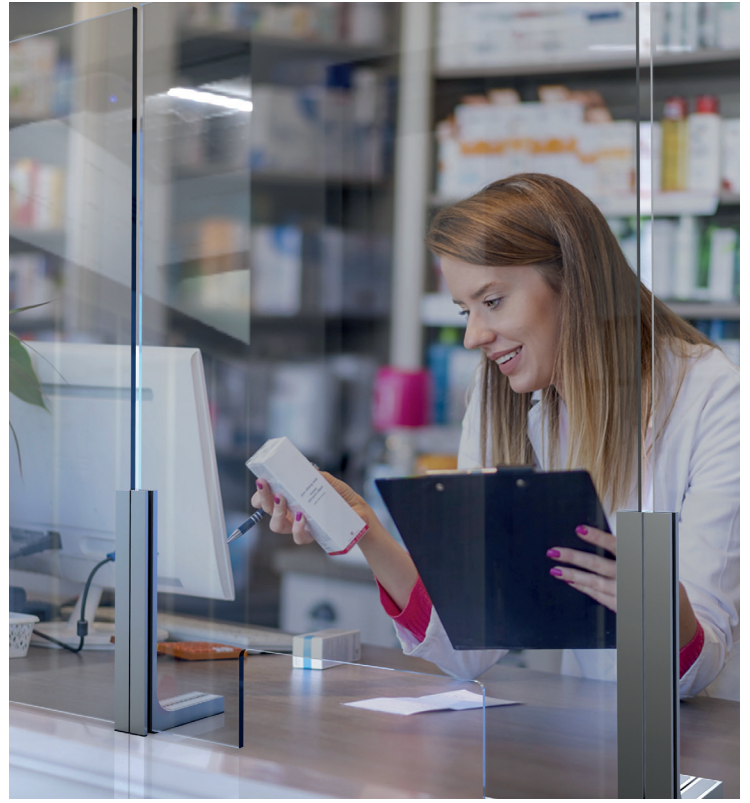

• PHARMACY/ RETAIL STORES



Glass Standoff - 9342/9001 Series

Glass Thickness: 1/4"~1/2" (6~12 mm)
 Material: Zinc Alloy
 Finish: Stainless Steel, Aluminum,
 Powder Coated, Matte Brushed



Glass Standoff - 8449 Series

Glass Thickness: 1/4"~ 3/8" (6~10 mm)
 Material: Zinc Alloy
 Finish: Stainless Steel, Aluminum,
 Powder Coated, Matte Brushed



Glass Standoff - 3001 Series

Glass Thickness: 1/4" (6 mm)
 Material: Zinc Alloy
 Finish: Stainless Steel, Aluminum

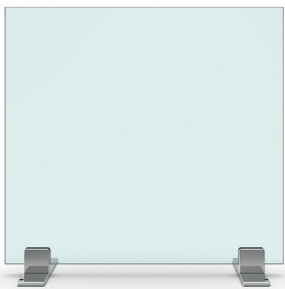

Showing the 9342/9001 Series



Showing the 8449 Series

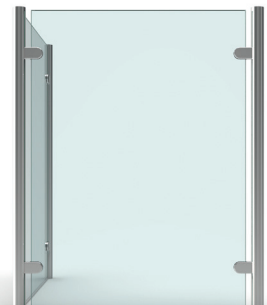

Showing the 3001 Series

Please note: These are examples of applications, Sugatsune does not sell the glass or acrylic with the hardware itself.



Glass Standoff - 5200/5201 Series
 Glass Thickness: 5/16" (8 mm)
 Material: Zinc Alloy
 Finish: Aluminum



Glass Standoff - 2880
 Glass Thickness: 1/4"~ 3/8" (6~10 mm)
 Material: Zinc Alloy or 304 Stainless Steel



Glass Standoff - 2881
 Glass Thickness: 1/4"~ 3/8" (6~10 mm)
 Material: Zinc Alloy



Glass Standoff - 2885
 Glass Thickness: 1/4"~ 3/8" (6~10 mm)
 Material: Zinc Alloy or 304 Stainless Steel



Glass Door Hinge - GH-34
 Glass Thickness: 3/16"~1/4" (4~6 mm)
 Material: 304 Stainless Steel



Angle Bracket - SU-A
 Load Capacity: 22~52 lbs (10~24 kg)
 Material: 304 Stainless Steel



Angle Bracket - SU-B
 Load Capacity: 22~28 lbs (10~13 kg)
 Material: 304 Stainless Steel



Angle Bracket - SV
 Glass Thickness: 1/4" (6 mm)
 Material: 304 Stainless Steel



Angle Bracket - SU
 Glass Thickness: 1/4" (6 mm)
 Material: 304 Stainless Steel



Angle Bracket - BT, BTK, BTW
 Load Capacity: 33~181 lbs (15~82.5 kg)
 Material: 304 Stainless Steel, Steel



Stainless Steel Knobs - EY-127, EY-207, EY-320, EY-326, EY327
 Material: 304 Stainless Steel
 Finish: Satin

FLEXIBLE style

TORQUE HINGES & PANEL MOUNTING CLIPS

These are great products to use for functional sneeze or spit guards. Because of the torque and movement range, these products create a more flexible application. Panel mounting clips can provide a flexible solution for easy removable panels on counters, service doors or seating.

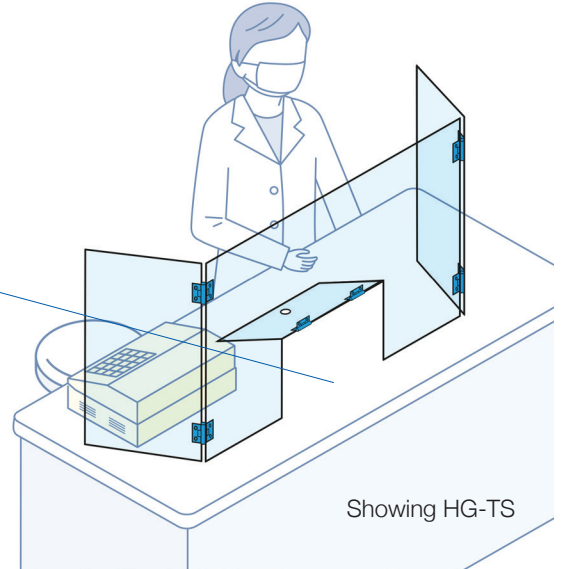
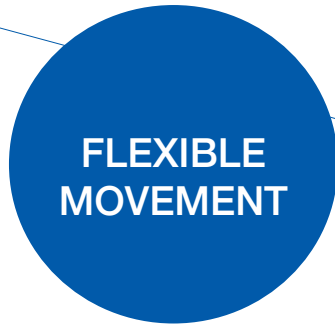

Torque Hinge - HG-TS
 Material: 304 Stainless Steel
 Free stop between 0~180 degrees



Glass Standoff - 4884 Series
 Glass Thickness: 3/16" ~ 5/16" (5~8 mm)
 Material: Stainless Steel

Glass Standoff - 4885 Series
 Glass Thickness: 3/16" ~ 5/16" (5~8 mm)
 Material: Stainless Steel

Glass Standoff - 8175/ 8187 Series
 Glass Thickness: 1/4", 5/16", 3/8" (6, 8, 10 mm)
 Material: Stainless Steel

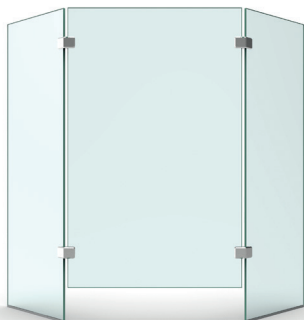

Showing the 4884 Series



4885 Series

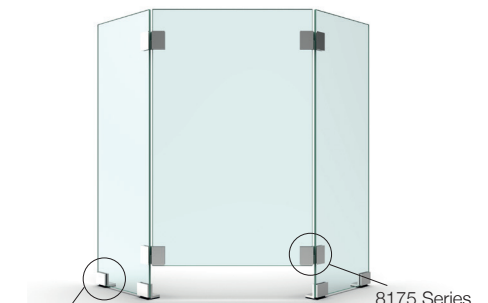

8187 Series

8175 Series

8175/8187 Series

Please note: These are examples of applications, Sugatsune does not sell the glass or acrylic with the hardware itself.



FASTMOUNT

Fastmount® Ltd is an innovative hidden panel mounting system for interiors which provides a superior panel finish with perfect alignment. Designed and manufactured in New Zealand, Fastmount clips can easily be applied to acrylic panels with most 2-part epoxies.



Very Low Profile - VL-03H

Heavy duty surface or recessed mounting.
 Pull out force: 22 lbs (10 kg)



Low Profile Range - LP-F8

Self tapping, mounts into 1" (25 mm) hole.
 Fits into plywood and MDF boards.



Surface Mount Clip - PC-SM2

Adhesive fix for heavy duty applications.
 Pull out force: 22 lbs (10 kg)

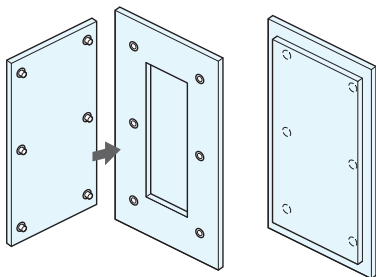

Easy Clip-On

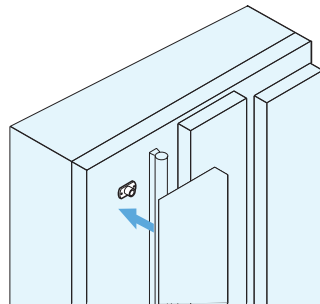

Panel Mounting

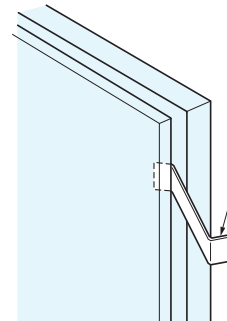

Easy Removable Panels



Ventilator - APK, APKL

Material: Plastic
 Can be used as a guard for speaking.



Ventilator - SAM

Material: 304 Stainless Steel
 Can be used as a guard for speaking.



Ventilator - 1-212

Material: 304 Stainless Steel
 Can be used as a vent to more clearly hear through the acrylic shield.

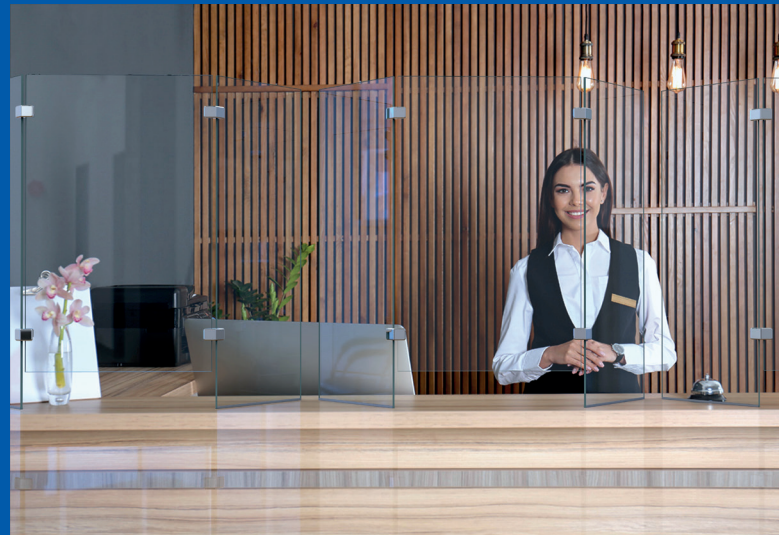
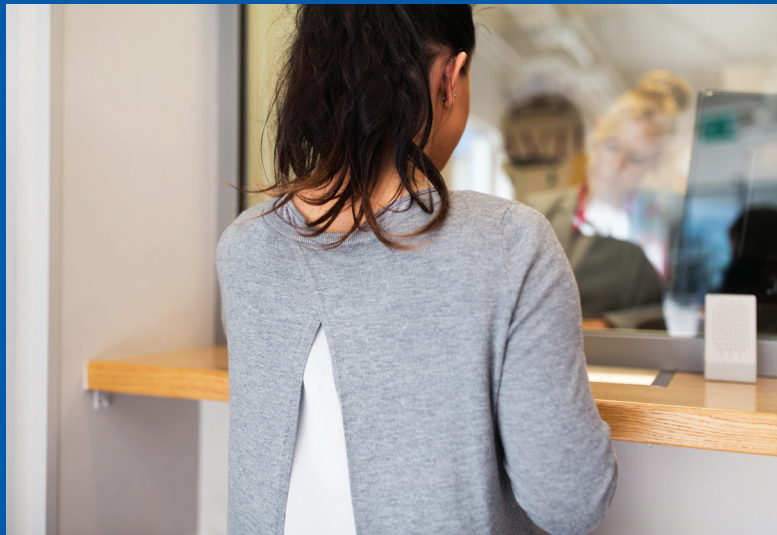

DISCLAIMER:
 Specifications, features, illustrations, certifications and materials shown in this catalog are based upon the latest available information at the time of publication. Although descriptions are believed to be correct, accuracy cannot be guaranteed. Sugatsune reserves the right to make changes at any time, without notice or obligation, in finishes, materials, sizes, specifications and availability and disclaims any and all liability for typographical, printing or production errors or changes affecting the products and/or specifications contained herein. Actual performance of products may vary based upon many factors and may be less than stated. Differences in construction and build materials, designs or configurations may affect product performance and are satisfied.



Sugatsune America, Inc.
 18101 Savarona Way
 Carson, CA 90746
 Fax: 310-329-0819
 Phone: 310.329.6373
 E-mail: Sales@sugatsune.com
 www.sugatsune.com

